



THE SPECIALIST
FOR MOTION
TECHNOLOGY

PRODUCT PROGRAM





NADELLA / nadella.com
DURBAL / durbal.com
CHIAVETTE UNIFICATE / chiavette.com
IPIRANGA / ipirangahusillos.com
SHUTON / shuton.com

THE SPECIALIST FOR MOTION TECHNOLOGY

Nadella Group is an expert system partner for all areas of motion technology, with specialized manufacturer companies and a worldwide sales network.

Wherever innovative ideas, customized solutions, precision and reliability are required, developers and design engineers rely on products and solutions from the Nadella Group.

COMPANIES, BRANDS AND PRODUCTS OVERVIEW

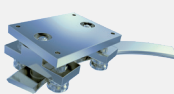

Linear Guides

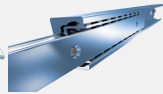

Telescopic Rails

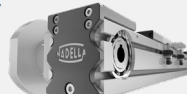

Linear Modules



Linear Axes and Systems



Circular Systems



Bearings and Cam Followers



Adjusting Nuts & Rings

durbal

TESCUBAL

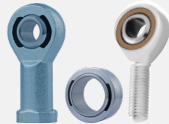

Rod Ends and Spherical Plain Bearings



Clevises and Ball/Axial Joints



Precision Ball Screws



Rolled Ball Screws

MILESTONES

1930

NADELLA foundation in France

1958

Founding of NADELLA GMBH in Germany

1963

Founding of NADELLA S.P.A. in Italy

1984

Start of development and sale of Nadella Linear

2012

New Nadella subsidiaries in China and USA

2014

Acquisition of DURBAL

2018

Acquisition of CHIAVETTE UNIFICATE

2019

Founding of Nadella Motion Technology Changxing Co. Ltd.

2020

New Nadella subsidiaries in France and Spain
Acquisition of SHUTON and IPIRANGA

2021

Acquisition of DAMO

KEY NUMBERS

1 Group

8 manufacturing plants

14 main locations

Italy, Germany, France, Poland, Spain, United Kingdom, U.S.A., China

leading the way in the international markets

in over **60** countries

for more than **90** years

APPLICATION SECTORS



RAILWAY TECHNOLOGY



WAREHOUSE & LOGISTICS



MEDICAL ENGINEERING



FOUNDRY & IRONWORKS



ROBOTICS AUTOMATION



PACKAGING INDUSTRY



AEROSPACE TECHNOLOGY



PHARMACEUTICAL PRODUCTION

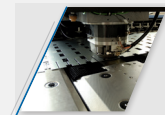

CUTTING & WELDING

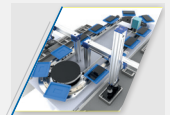

HI-TECH PRODUCTION

COMPLETE SOLUTIONS AND SYSTEMS

LINEAR SYSTEMS

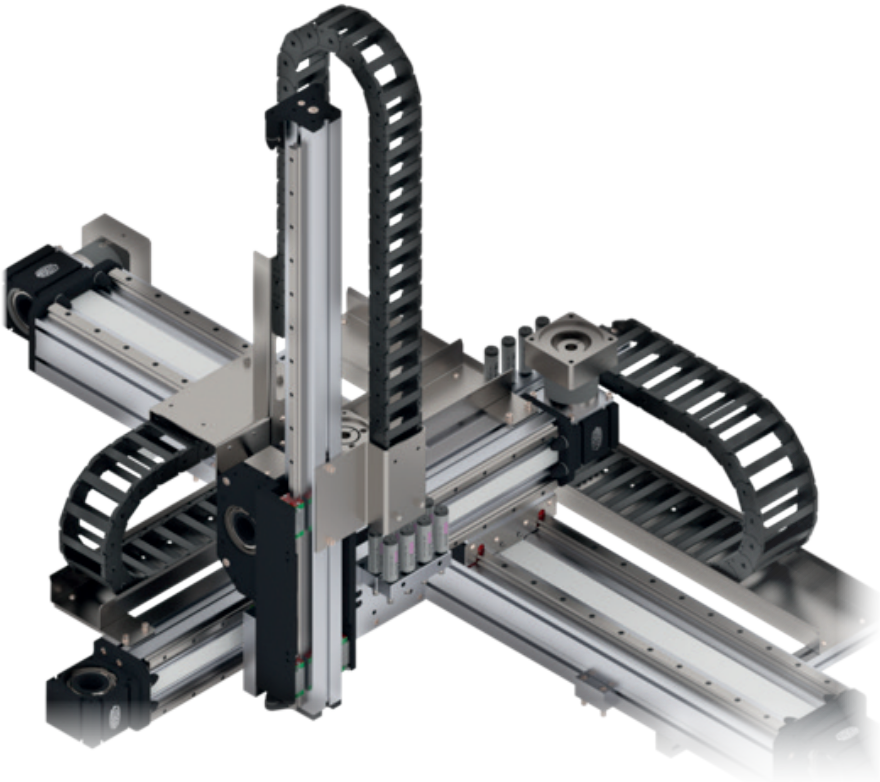

Nadella Group, global partner for Motion Solutions, is a specialist in linear axes and cartesian systems, offering a wide range of solutions with best in class quality standards.

Direct management of design and application engineering and our production workshop equipped with the latest generation machine tools, allow us to create both standard and customized systems efficiently providing a complete service based on customer needs.

Our multi-axes systems consist of various combinations of directly driven linear modules with different sizes, types and configurations.

Customized solutions are developed based on the application requirements in terms of load, stroke, dynamics and speed.

CIRCULAR SYSTEM AXNR

Nadella AXNR circular module is a further development of Nadella FSR circular rails. AXNR module is a reliable and cost competitive solution. The product is based on the combination of components to allow product definition and availability in short time. Modifications or special versions to meet specific requirement are possible.

The Nadella AXNR circular system is composed by the following elements: aluminum basement, guide rails and carriages, transmission by gearbox and toothed belt, lubrication units and carriage indexing for precise carriage location.

AXNR circular system has the following outstanding advantages:

- | Nadella as leader in the V guides market provides guide rollers characterized by high load capacity, stiffness and precision, necessary to obtain regular movements and accurate positioning.
- | A special Durbal rod end design of connection between toothed of entire system.
- | Aluminum alloy machined base directly connected to the gearbox lead to a space-saving system, meanwhile a steady and easy mounting solution.
- | Customized solution and complete system are available thanks to flexible configuration.

APPLICATION EXAMPLE TEST LINE

This high efficiency space-saving test line is possible due to the combination of the AXNR Circular System and AXNR actuators, which provides an automatic unmanned solution on every process.

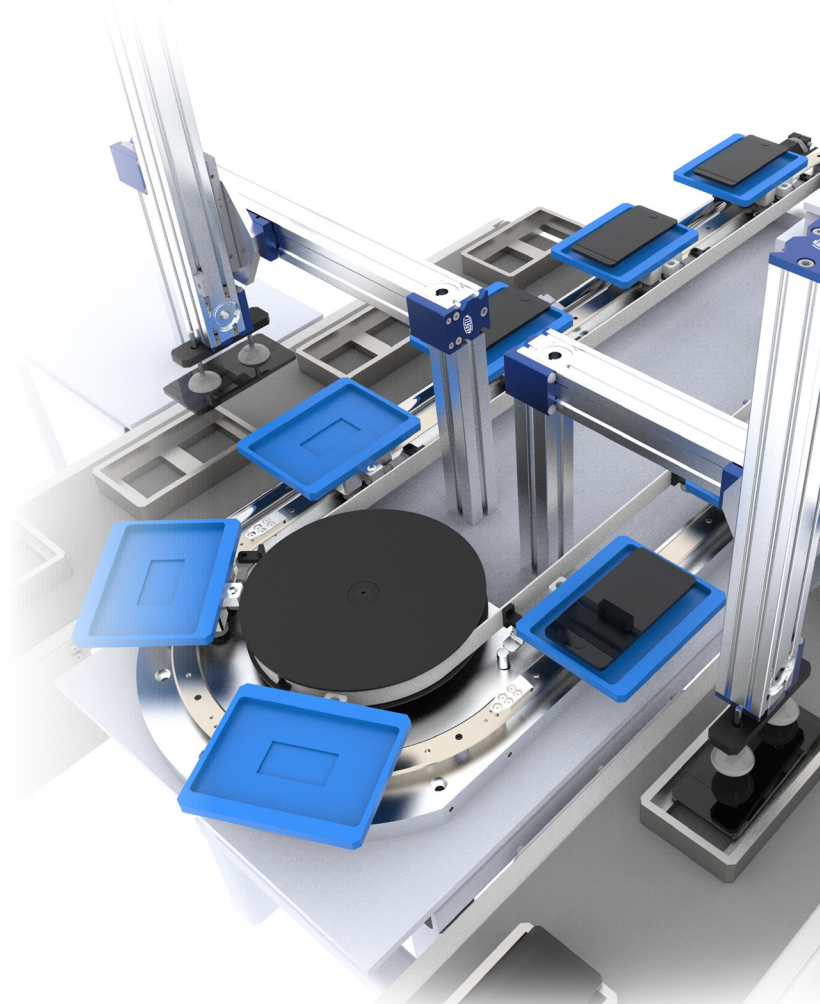

LINEAR MOTION, THE RIGHT SOLUTION FOR ANY REQUIREMENT

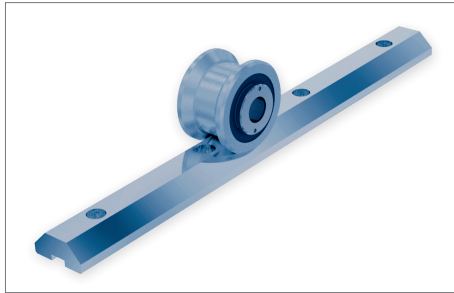

> HEAVY-LINE GU GUIDES

- | For medium to heavy load applications
- | Tapered roller bearings
- | Harden steel or stainless steel rails
- | Cold drawn profiles
- | Speed up to 10 m/s (32 ft/s)
- | Linear accuracy 0.5 mm/m (0.019" / 3 ft)
- | Rail length up to 6000 mm / 20 ft length
- | Optional lubricators and wipers
- | 3 Sizes available & joinable rails

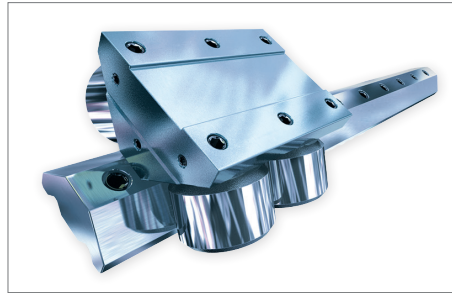

> ROLBLOC BL AND BL..DS

- | Medium to heavy load applications
- | 3 Sizes available
- | Linear speed 4 m/s (13 ft/s)
- | RS seals type and lubricated for life bearings
- | Rails up to 6000 mm / 20 ft length
- | Machined or ground rails
- | Complete kit assemblies

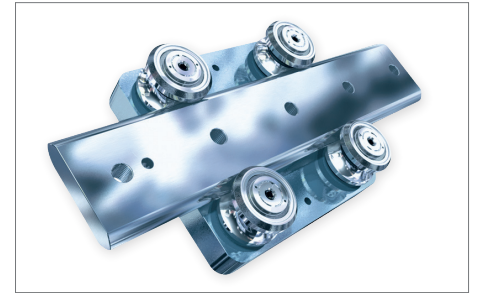

> V-LINE FS AND FSH GUIDES

- | Induction-hardened steel or stainless steel rails
- | Low noise and vibration
- | Speed up to 4 m/s (13 ft/s)
- | Rails up to 6000 mm / 20 ft length
- | Double or single sided rails
- | 9 Sizes available
- | Cold drawn or ground surfaces
- | 3 Different bearing types available

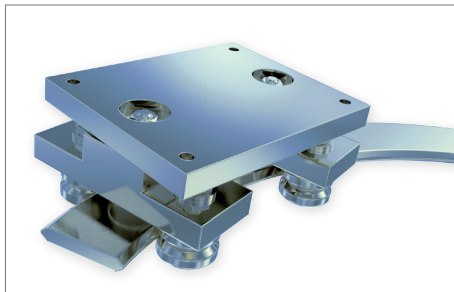

> MULTI MOTION LINE CIRCULAR GUIDES

- | Circular rails based on V-Line profiles
- | Standard and custom radius
- | Steel or stainless steel systems
- | Fixed or pivoting carriages
- | Nickel plating available
- | Seven rail radius available on stock
- | Easy joining & mounting hardware
- | Ground surfaces

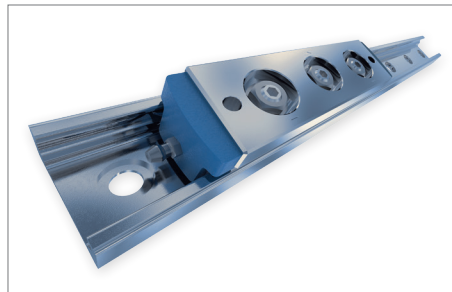

> C-LINE LS GUIDES

- | For moderate load applications
- | Self-aligning system
- | High speed up to 8 m/s (26 ft/s)
- | Acceleration up to 20 m/s² (65 ft/s²)
- | Self-lubrication & wipers
- | 3 Sizes available
- | Rails up to 6000 mm / 20ft length
- | In zinc or nickel plating
- | Short & long slider

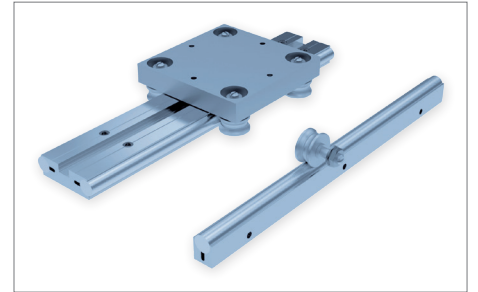

> BASE-LINE C AND DC GUIDES

- | For light and medium load applications
- | Low profile design & easy mounting
- | Corrosion resistant materials available
- | Lightweight aluminum body
- | Harden steel or stainless steel shafts
- | Rails up to 6000 mm / 20ft length
- | Up to 10 m/s (32 ft/s) speed
- | Self-lubrication and wipers available

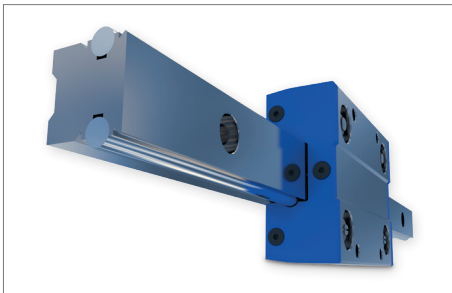

> FLEXI-LINE 645

- | Dimensions according to DIN 645 with flexible configuration
- | Ready-to-install
- | For light and medium load applications
- | Low profile design & easy mounting
- | Corrosion resistant materials
- | Lightweight aluminum body
- | Harden steel or stainless steel shafts

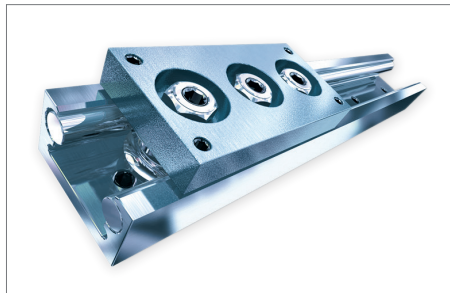

> U-LINE LM GUIDES

- | For light and medium load applications
- | Compact U-profile with inside carriage
- | Corrosion resistant materials
- | Self-alignment system
- | Rails up to 6000 mm / 20ft length
- | 6 sizes available
- | Up to 10m/s (32 ft/s) speed
- | Joinable rails



> TELESCOPIC LINE

- | Moderate to heavy load applications
- | Part-, Full- and Overextensions
- | Loads from 10 up to 2000 kg (up to 4400 lbs)
- | Steel, stainless steel or aluminium available
- | Soft stops, locking devices and wipers, end position damping, double-sided extension and much more available
- | Up to 3000 mm / 10ft strokes
- | Standard and custom made products

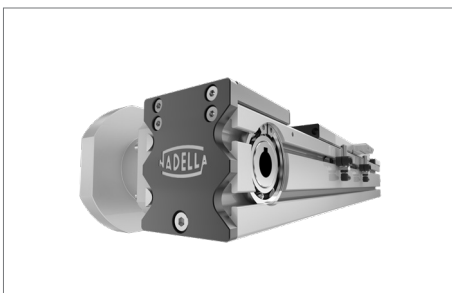

> LINEAR MODULES

- | Drive with toothed belt or ball screw or rack/ pinion
- | Light to heavy load applications
- | Robust roller bearing and ball rail versions
- | Speed up to 10 m/s (33 ft/s)
- | Strokes up to 12 m in single beam
- | Gearbox configurations available
- | Steel reinforced AT belt
- | Belt covers
- | Steel pulleys for longer life



> LINEAR SYSTEMS

- | Integrated solution for multi-axes systems (manipulator, portals, 7th axes)
- | Customisable with accessories (cables chain, gearbox, automatic lubrication and bumpers)
- | Steel frame (upon request)

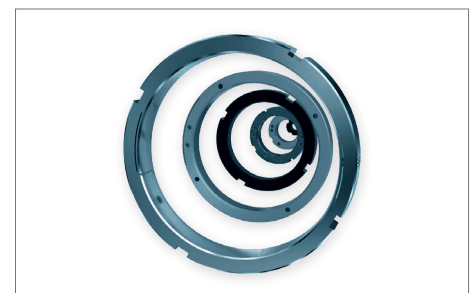

> ADJUSTING NUTS AND THREADED RINGS

- | A precise and powerful locking of bearings in axial positioning after assembly
- | Time-saving through a more simple technical design and construction of shaft-bodies and assemblies
- | No use of locking washers, thus preventing seal damage
- | Clamping and locking the adjusting nut without any loss of axial precision
- | Easy mount and release re-usable many times without loss of precision
- | Recommended use under severe conditions (ex. High-temperature, vibrations)

ROTATIONAL MOVEMENT, HIGH PRECISION

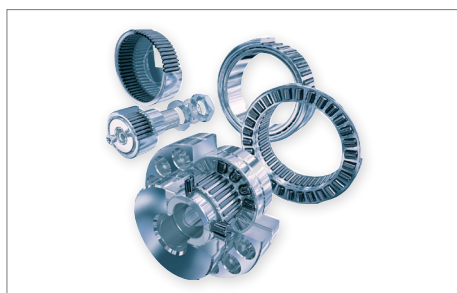

> NEEDLE BEARINGS

- | Light to heavy load applications
- | Sizes up to 300 mm / 12"
- | Smallest sizes in industry
- | Needle bearing full complement or caged
- | Highest precision on market
- | Patented thrust bearing with retainer plate for kit assembly
- | Combined bearing in 2-piece version
- | Complete kit assemblies or just bushings and needles

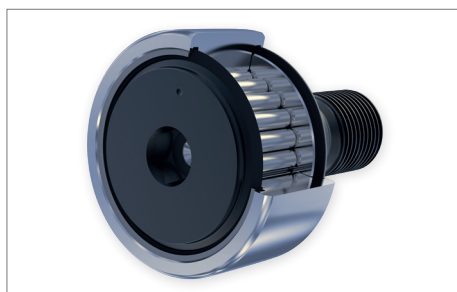

> CAM FOLLOWER AND TRACK ROLLERS

- | Light to heavy load applications
- | Sizes from 5 to 320 mm / 0.19" to 12.6"
- | Concentric and eccentric versions
- | Double CAM and custom designs
- | Metal seals for harsh environments
- | Steel and stainless Steel systems
- | Special materials and corrosion protected versions
- | Complete kit assemblies
- | Two different bearing configurations
 - Needle Bearing
 - Taper Roller Bearing



> ROD ENDS AND SPHERICAL PLAIN BEARINGS

- | With roller or ball bearing version in metric sizes from 6 to 40 mm and inch sizes from 0.25 to 1"
- | With sliding bearings, maintenance free (DURBAL Glide) or maintenance required from sizes 4 to 1000 mm and inch sizes from 0,25 to 6"
- | For custom made linkages solutions as a modular combined system and, on request, special products according to drawing
- | In aluminum or stainless steel version or with special coating (DURBAL Coat)
- | For hydraulic cylinders with female thread or with welding ends



> ROD ENDS AND LINKAGES

- | TESCUBAL and TESNO self-lubricating rod ends and spherical bearings according to DIN - ISO 12240
- | Clevises DIN 71752 and accessories (plated, stainless steel, aluminum)
- | Angular joints DIN 71802 and axial joint
- | Rod assemblies according to customer specifications
- | Ball stud DIN 71803
- | Ball socket DIN 71805
- | Self-aligning joint for pneumatic cylinders



PRECISION BALL SCREWS, OPTIMIZED FOR EVERY APPLICATION



> HIGH PERFORMANCE BALL SCREWS

- | Applications: High demand machine tool
- | High dynamics & efficient rigidity
- | DN up to 210.000
- | Speed up to 100m/min
- | Acceleration up to 15m/s²
- | Diameter 16-200mm
- | Length up to 15m in single piece
- | Single and double nut types
- | Different type of nut preloading is available
- | Multiple start thread option
- | Quality classes IT1, IT3 and IT5



> HIGH LOAD & HIGH DYNAMIC BALL SCREWS

- | Applications: Injection machines, presses buildings shock absorbers, boarding bridges and other heavy duty applications
- | DN up to 210.000
- | Diameter 40-200mm
- | Nut length up to 600mm
- | Multiple start thread option
- | Quality classes IT1, IT3 and IT5

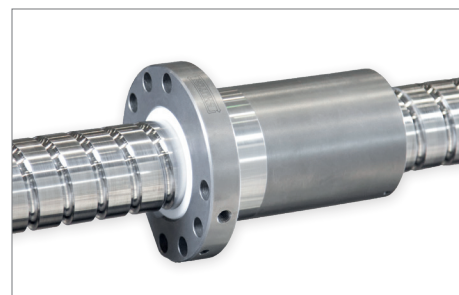

> POSITIONING BALL SCREWS

- | Applications: pick and place applications, factory automation, actuators, Machine tool, Grinding Machine, EDM machines
- | DN up to 210.000
- | Diameter 16-160mm
- | Double and Single nut types
- | Multiple start thread option
- | Quality classes IT1, IT3 and IT5



> ROTARY NUT SYSTEMS

- | Applications: High demand machine tool
- | High dynamics & efficient rigidity
- | DN up to 210.000
- | Speed up to 100m/min
- | Acceleration up to 15m/s²
- | Diameter 40-125mm
- | DN up to 210.000
- | Length up to 15m in single piece
- | Different type of nut preloading is available
- | Multiple start thread option
- | Quality classes IT1, IT3 and IT5



> ROLLED BALL SCREWS

- | Applications: pick and place applications, factory automation, actuators and other transport solutions
- | Diameters from 16mm to 63mm
- | Leads from 5mm to 50mm
- | Lengths up to 6 meters
- | DIN shape nuts
- | Multiple start thread option
- | Quality classes IT5 and IT7



> TURNKEY PROJECTS

- | Coatings (Phosphatation, Chromium, Bluing ...)
- | Out of standard material manufacturing
- | Special shape nuts, asymmetric, square
- | Customised sealing solutions
- | Embedded or integrated safety nut
- | Customised end machining
- | Sensorized nuts
- | Ceramic balls



NADELLA / nadella.com
DURBAL / durbal.com
CHIAVETTE UNIFICATE / chiavette.com
IPIRANGA / ipirangahusillos.com
SHUTON / shuton.com

THE SPECIALIST FOR MOTION TECHNOLOGY

Our customers' satisfaction is the basis for our success and growth.
That is why we are at your service around the world and always keep your requirements as a priority.

We have a worldwide network of sales engineers and distributors in Europe, Asia and the USA.
This allows us to ensure customer-oriented solutions and best in class delivery and service.

WORLDWIDE NETWORK

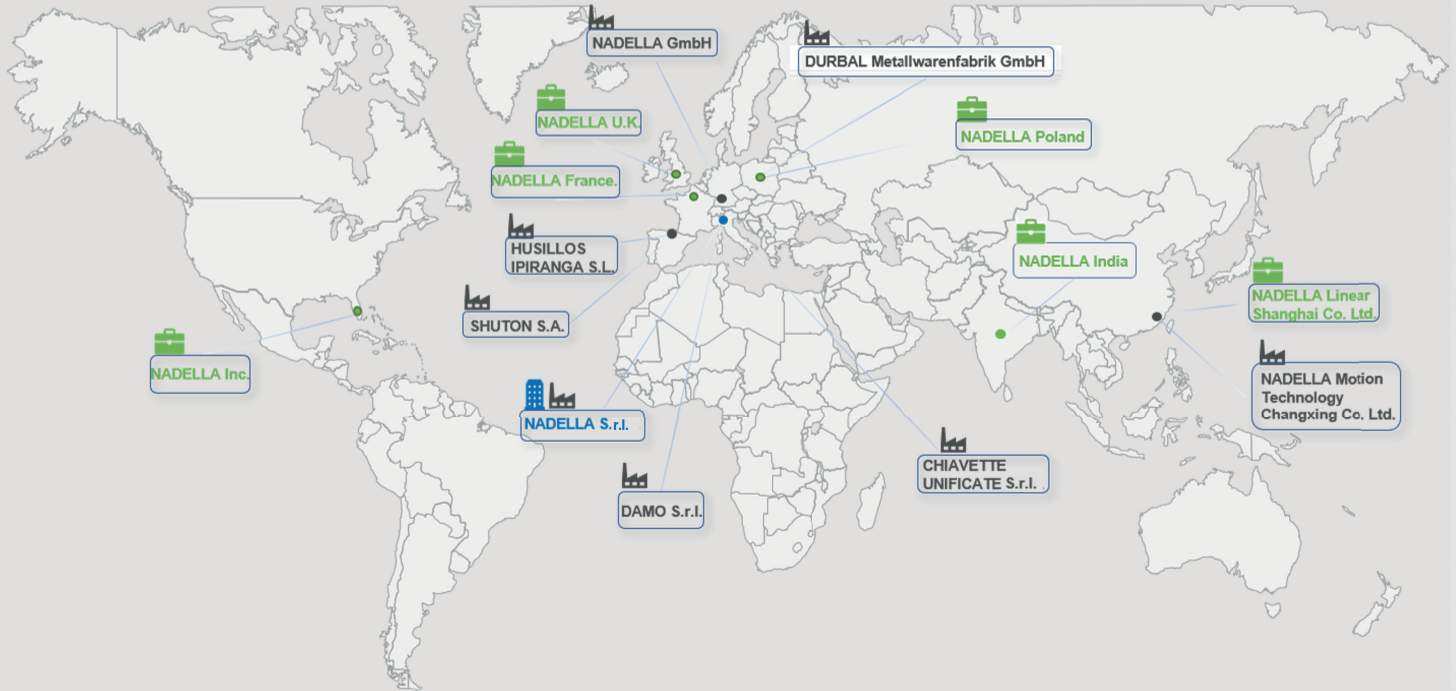

BRANCHES AND CONTACTS

NADELLA S.r.l. Italy

Via Melette, 16
20128 Milano
Tel.: +39 02 27 093
Fax: +39 02 257 64 79
customer.service@nadella.it
www.nadella.it

NADELLA S.A. Spain

Poligono Industrial Erratzu
Parcela G3. Pabellón 221 -
Apdo. 65
E-20130 Urnieta - Gipuzkoa
Tel. +34 943 336 370
ventas@nadella.es
www.nadella.com

NADELLA GmbH Germany

Rudolf-Diesel-Str. 28
71154 Nufringen
Tel.: +49 7032 9540-0
Fax: +49 7032 9540-25
info@nadella.de
www.nadella.de

DURBAL Metallwarenfabrik GmbH - Germany

Verrerberger Weg 2
74613 Öhringen
Tel.: +49 7941 9460-0
Fax: +49 7941 9460-90
info@durbal.de
www.durbal.de

NADELLA Inc. United States

14115 - 63 Way North
Clearwater - Florida 33760-3621
Tel.: +1 844-537-0330 (toll-free)
Tel.: +1 844-537-0331
info@nadella.com
www.nadella.com

CHIAVETTE UNIFICATE S.r.l. Italy

Via G. Brodolini 6-8-10
40069 Zola Predosa, Bologna
Tel.: +39 051 75 87 67
Fax: +39 051 75 47 80
tescubal@chiavette.it
www.chiavette.com

NADELLA Linear Shanghai Co. Ltd. - China

F4, Bld5, No.2388 Chen-hang
Road Shanghai 201114
Tel.: +86 21 5068 3835
Fax: +86 21 5038 7725
info@nadellamotion.com
www.nadellamotion.com

SHUTON S.A. Spain

Poligono Industrial Goian
C/Subino, 5 - 01170 LEGUTIANO
Tel.: +34 945 465 629
Fax: +34 945 465 610
shuton@shuton.com
www.shuton.com

NADELLA France France

12 Parvis Colonel Arnaud Beltrame
Hall A 4ème étage
78000 Versailles
Tel.: +33 (0)1 7319 4048
service.client@nadella.fr
www.nadella.fr

HUSILLOS IPIRANGA Spain

Poligono Industrial Erratzu
Parcela G3. Pabellón 221 - Apdo.65
E-20130 Urnieta - Gipuzkoa
Tel. +34 943 336 370
info@ipirangahusillos.com
www.ipirangahusillos.com

NADELLA Poland Poland

Tel: +48 666 874 460
sales.pl@nadella.eu
www.nadella.com

NADELLA UK UK and Ireland

Tel: +44 7901 214 918
sales.uk@nadella.eu
www.nadella.com

DISTRIBUTOR COVERAGE

Austria	China	France	India	Korea	Portugal	Slovakia	Switzerland
Belgium	Czech Republic	Germany	Ireland	Netherlands	Romania	Slovenia	Taiwan
Brazil	Denmark	Great Britain	Israel	Norway	Russia	Spain	Turkey
Canada	Finland	Hungary	Italy	Poland	Singapore	Sweden	United States

WWW.NADELLA.COM

